

PER:  
FOR:

## ALA (I)

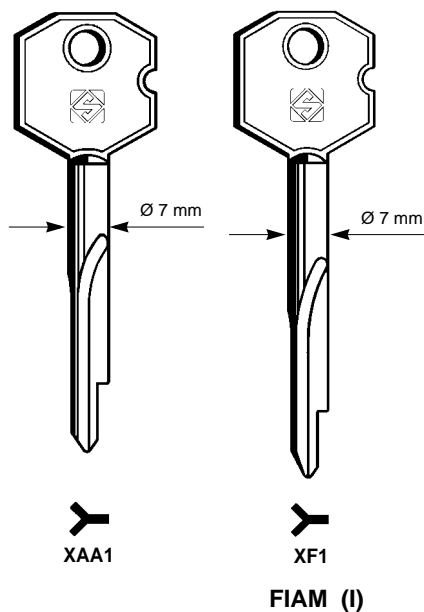

OPTIONAL

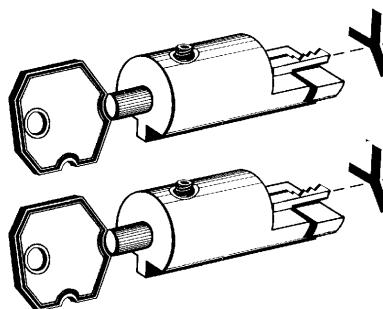

### D701812ZB

Adaptors for XAA1-XF1 keys  
Adattatori per chiavi XAA1-XF1  
Adapters für XAA1-XF1 Schlüssel  
Adaptateurs pour clés XAA1-XF1  
Adaptadores para llaves XAA1-XF1

PER:  
FOR:

## BKS (D)

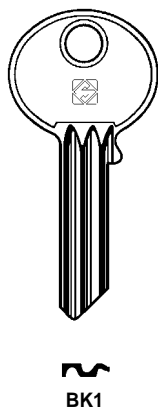

OPTIONAL

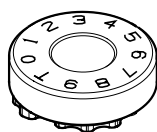

### D717878ZB

Cam  
Camma  
Camma  
Cam  
Cam

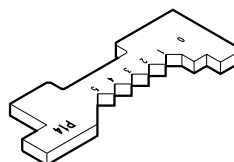

### D717628ZB

Plate  
Piastrina  
Plättchen  
Plaque  
Chapeta



### D717879ZB

Cutter 80x7,9x16  
Fresa 80x7,9x16  
Fräser 80x7,9x16  
Fraise 80x7,9x16  
Fresa 80x7,9x16

To fit on D709300ZB device

Da applicare al dispositivo D709300ZB

Die auf D709300ZB Code-Vorrichtung zu installieren

À installer sur le dispositif D709300ZB

A instalarse en el dispositivo D709300ZB

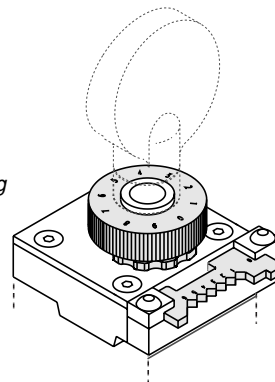

# BRAVO EVOLUTION



PER:  
FOR:

## ASSA (S)

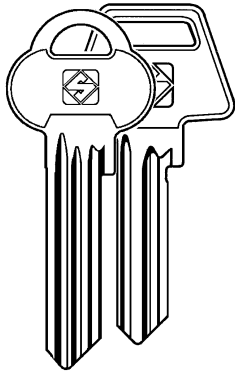

RUKO (DK)

OPTIONAL

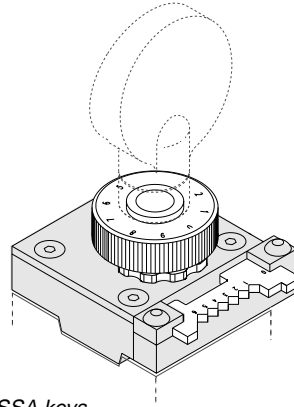

### D709300ZB

Code attachment for ASSA keys  
Dispositivo a codice per chiavi ASSA  
Code-Vorrichtung für ASSA Schlüssel  
Dispositif à code pour clés ASSA  
Dispositivo a código para llaves ASSA

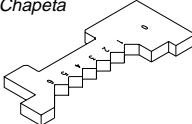
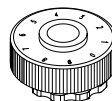
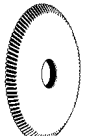
	Code Codice	SILCA Ref.	TWIN orig.	ASS2	ASS2R	ASS7	ASS44	ASS3	ASS12	ASS53	ASS4R	ASS45	ASS52R	RUKO orig.
Plate Piastrina Plättchen Plaquette Chapeta  	P1	D709304ZB	●											
	P2	D709981ZB		●	●									
	P3	D709982ZB				●	●							
	P4	D709983ZB						●	●					
	P5	D709984ZB								●				
	P6	D709985ZB									●	●		
	P7	D709986ZB											●	
	P8	D710005ZB												●
Cam Camma Camma Cam Cam  	C1	D709987ZB		●	●	●	●	●	●	●	●	●	●	
	C2	D709303ZB	●											
	C3	D710006ZB												●
Cutter Fresa Fräser Fraise Fresa  	P13	D709993ZB	●											●
	P14	D709992ZB		●	●	●	●	●	●	●	●	●	●	

PER:  
FOR:

## BLUMA (I)

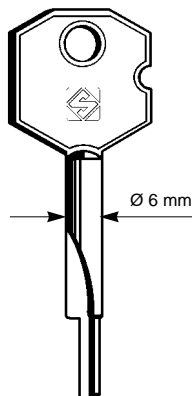

→  
XB1

OPTIONAL

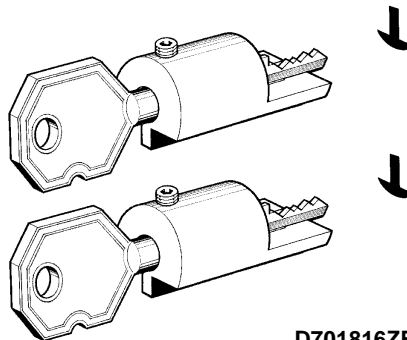

### D701816ZB

Adaptors for XBW5-XB1 keys  
Adattatori per chiavi XBW5-XB1  
Adapters für XBW5-XB1 Schlüssel  
Adaptateurs pour clés XBW5-XB1  
Adaptadores para llaves XBW5-XB1



PER:  
FOR:

## BRICARD (F)

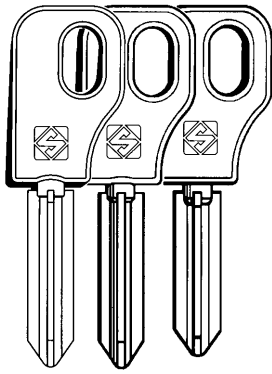

XBD7 XBD4 XBD3

OPTIONAL

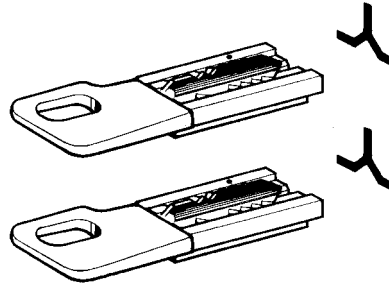

### D701814ZB

Adaptors for BRICARD keys  
Adattatori per chiavi BRICARD  
Adapters für BRICARD Schlüssel  
Adaptateurs pour clés BRICARD  
Adaptadores para llaves BRICARD

PER:  
FOR:

## BURG WACHTER (D)

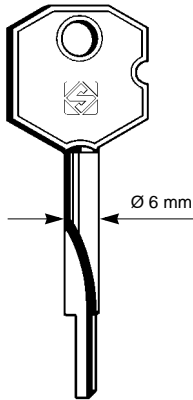

XBW5

OPTIONAL

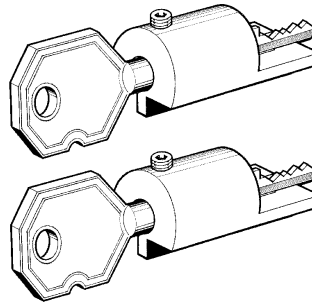

### D701816ZB

Adaptors for XBW5-XB1 keys  
Adattatori per chiavi XBW5-XB1  
Adapters für XBW5-XB1 Schlüssel  
Adaptateurs pour clés XBW5-XB1  
Adaptadores para llaves XBW5-XB1

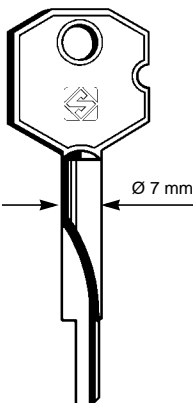

XBW4

OPTIONAL

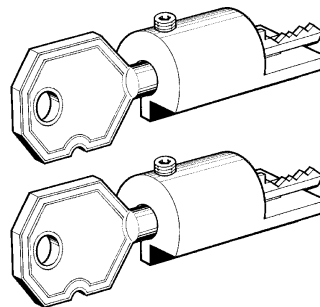

### D701815ZB

Adaptors for XBW4 keys  
Adattatori per chiavi XBW4  
Adapters für XBW4 Schlüssel  
Adaptateurs pour clés XBW4  
Adaptadores para llaves XBW4

# BRAVO EVOLUTION



PER:  
FOR:

## CAVITH (F)

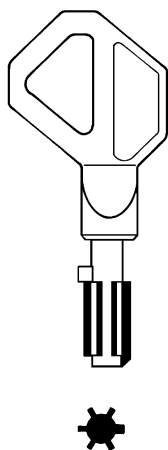

OPTIONAL



### D701817ZB

Adaptors for CAVITH keys  
Adattatori per chiavi CAVITH  
Adapters für CAVITH Schlüssel  
Adaptateurs pour clés CAVITH  
Adaptadores para llaves CAVITH

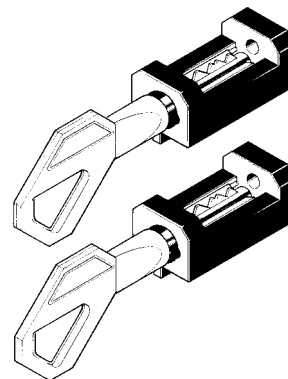

PER:  
FOR:

## CHRYSLER (USA)

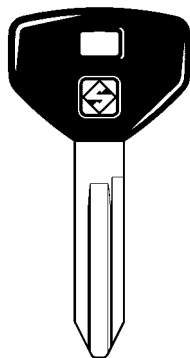

CY19P CY19

BRIGGS & STRATTON (USA)

OPTIONAL



### D709576ZB

Pair of shims  
Coppia spessori  
Passtücke  
Jeu de cales  
Par de chapas de espesor

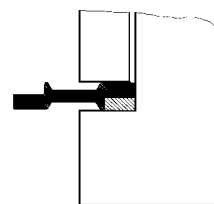
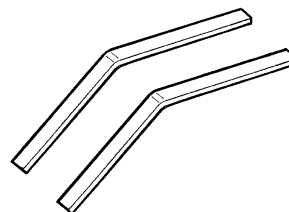

PER:  
FOR:

## CITROËN (F)

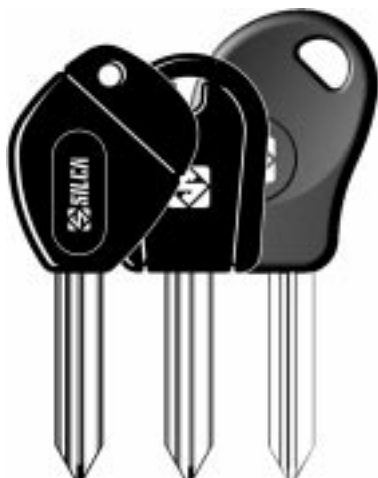

SX9CP SX9GP SX9T14  
SX9AP SX11BP SX10BP SX9T6

VALEO - SIMPLEX (F)

OPTIONAL

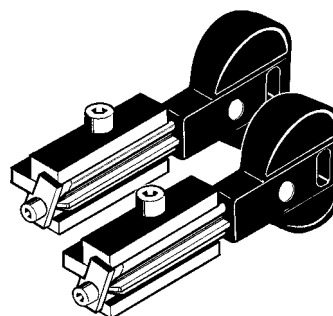

### D707754ZB

Adaptors for SIMPLEX keys  
Adattatori per chiavi SIMPLEX  
Adapters für SIMPLEX Schlüssel  
Adaptateurs pour clés SIMPLEX  
Adaptadores para llaves SIMPLEX



PER:  
FOR:

## CISA (I)

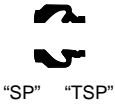
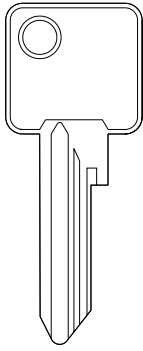

"SP" "TSP"

ABUS (D)

OPTIONAL

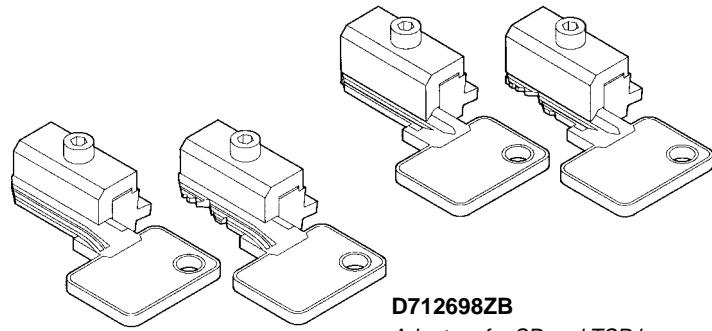

### D712698ZB

Adaptors for SP and TSP keys  
Adattatori per chiavi SP e TSP  
Adapter für SP und TSP Schlüssel  
Adaptateurs pour clés SP et TSP  
Adaptadores para llaves SP y TSP

PER:  
FOR:

## FAB (CZ)

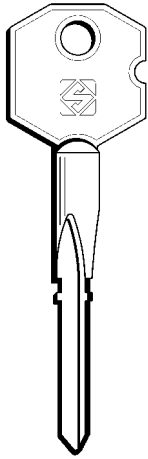

XFB1

OPTIONAL

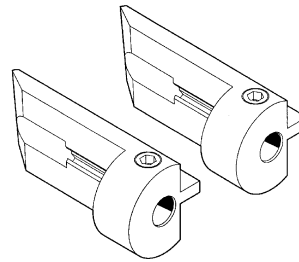

### D711171ZB

Adaptors for FAB cruciform keys  
Adattatori per chiavi a croce FAB  
Adapters für FAB Kreuzschlüssel  
Adaptateurs pour clés cruciformes FAB  
Adaptadores para llaves en cruz FAB

PER:  
FOR:

## FICHET (F)

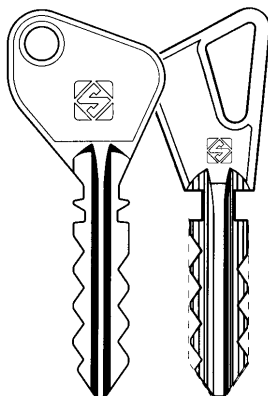

FT5C

FT4C

FT4

OPTIONAL

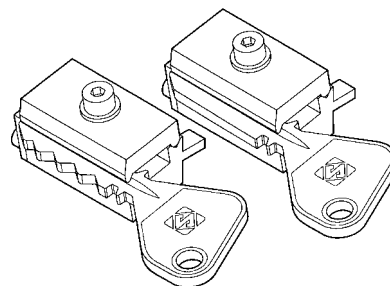

### D711513ZB

Adaptors for FT4-FT4C-FT5C keys  
Adattatori per chiavi FT4-FT4C-FT5C  
Adapters für FT4-FT4C-FT5C Schlüssel  
Adaptateurs pour clés FT4-FT4C-FT5C  
Adaptadores para llaves FT4-FT4C-FT5C

PER:  
FOR:

## FRIPA (D)

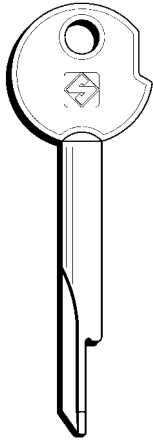

XFP1

OPTIONAL

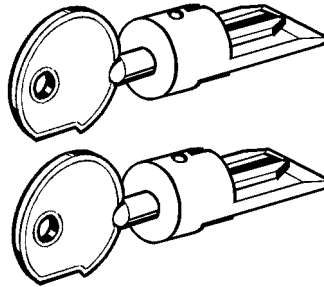

### D708369ZB

*Adaptors for FRIPA keys  
Adattatori per chiavi FRIPA  
Adapters für FRIPA Schlüssel  
Adaptateurs pour clés FRIPA  
Adaptadores para llaves FRIPA*

PER:  
FOR:

## HYUNDAI (J)

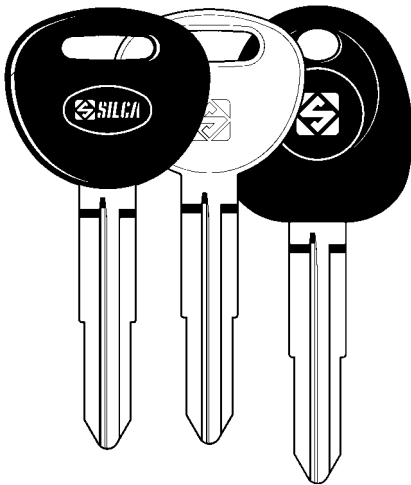

HYN10BP HYN10 HYN10T4

OPTIONAL

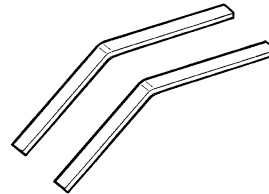

### D709576ZB

*Pair of shims  
Coppia spessori  
Passtücke  
Jeu de cales  
Par de chapas de espesor*

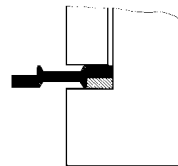

# BRAVO EVOLUTION



PER:  
FOR:

## PAPAIZ (BR)

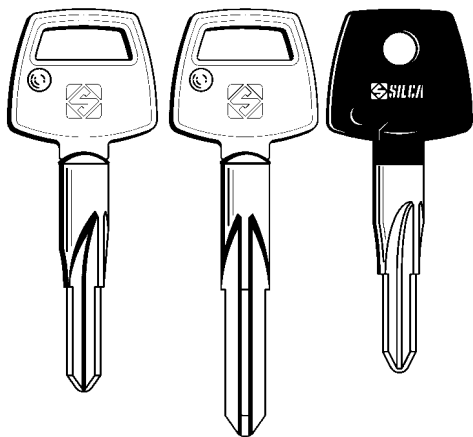

X  
XPZ1

+  
XPZ2

X  
XPZ3P

OPTIONAL

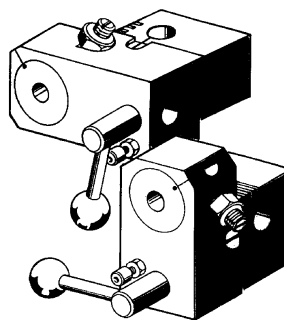

### D701895ZB

15° special jaws  
Coppia morsetti speciali 15°  
Sonderspannbacken 15°  
EtauX spéciaux 15°  
Mordazas especiales 15°

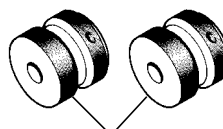

"C"  
Ø 8,5 mm

### D700334ZB

"C" optional keyholders  
Boccole opzionali "C"  
"C" Buchsen  
Douilles optionnelles "C"  
Casquillos opcionales "C"

PER:  
FOR:

## PORSCHE (D)

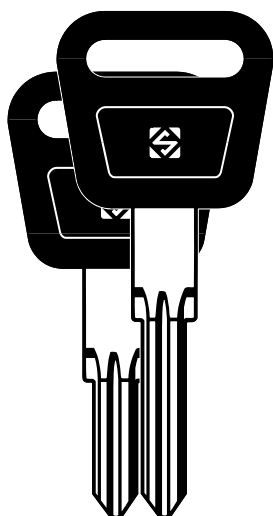

HU42P HU45P

HUF (D)

OPTIONAL

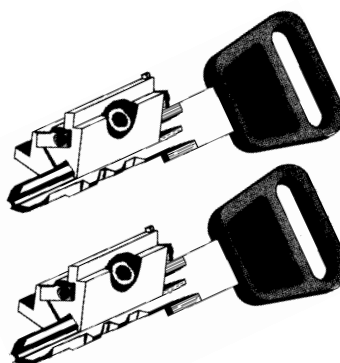

### D700011ZB

Adaptors for HU42P-HU45P keys  
Adattatori per chiavi HU42P-HU45P  
Adapters für HU42P-HU45P Schlüssel  
Adapteur pour clés HU42P-HU45P  
Adaptadores para llaves HU42P-HU45P



# BRAVO EVOLUTION



PER:  
FOR:

## RENAULT (F)

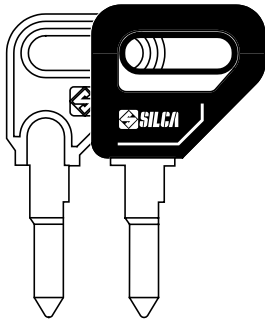

NE33S NE33SP  
VALEO - NEIMAN (F)

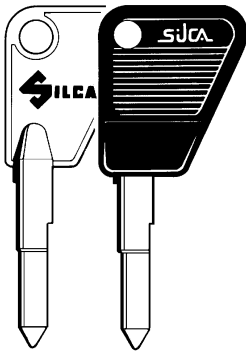

VAC64S VAC64SP  
VACHETTE (F)

OPTIONAL

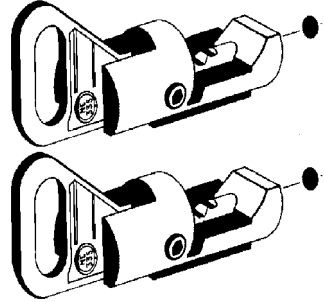

### D701813ZB

Adaptors for NE33S-VAC64S keys  
Adattatori per chiavi NE33S-VAC64S  
Adapters für NE33S-VAC64S Schlüssel  
Adaptateurs pour clés NE33S-VAC64S  
Adaptadores para llaves NE33S-VAC64S

PER:  
FOR:

## SAFE (I)

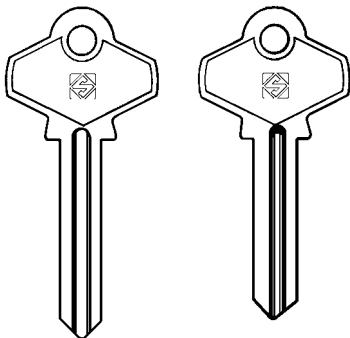

SF1

SF2

SF2R

OPTIONAL

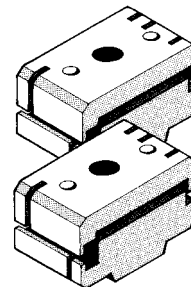

### D705438ZB

Jaws  
Set morsetti  
Spannbacken  
Étaux  
Mordazas



# BRAVO EVOLUTION



PER:  
FOR:

**SCHLAGE (USA)**

OPTIONAL

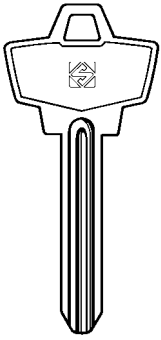

SH2

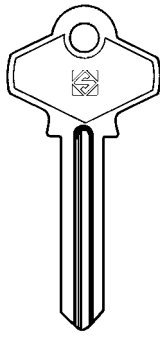

SH1

**D705438ZB**

Jaws  
Set morsetti  
Spannbacken  
Étaux  
Mordazas

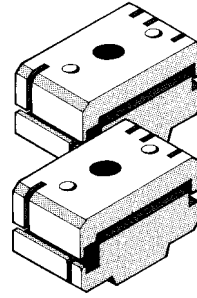

**ATTENTION:** for repairs or replacement of parts for maintenance, the 'CE' mark is guaranteed only if original spare parts provided by the manufacturer are used.

**ATTENZIONE:** in caso di riparazioni o sostituzione di pezzi per manutenzione, la marcatura "CE" è garantita solo se vengono utilizzate parti di ricambio originali fornite dal costruttore.

**ACHTUNG:** bei Reparaturen oder Auswechseln von Teilen zur Instandhaltung wird die CE-Markierung nur bei Verwendung von vom Hersteller gelieferten Originalersatzteilen gewährleistet.

**ATTENTION:** si vous effectuez des réparations ou que vous remplacez des pièces pendant un entretien, le marquage "CE" n'est garanti que si vous utilisez des pièces de rechange originales fournies par le fabricant.

**ATENCIÓN:** en caso de reparaciones o sustituciones de las piezas por mantenimiento, se garantiza la marca "CE" sólo si se utilizan partes de repuesto originales suministradas por el constructor.



**SILCA S.p.A.**

Via Podgora, 20 (Z.I.) 31029 VITTORIO VENETO (TV)

Tel. 0438 9136 Fax 0438 913800

[www.silca.it](http://www.silca.it)

Member of the Kaba Group

